

Rod Seals

Hallite



605

TECHNICAL DETAILS

METRIC

INCH

OPERATING CONDITIONS

MAXIMUM SPEED 1.0 m/sec
 TEMPERATURE RANGE -45°C + 110°C
 MAXIMUM PRESSURE 400 bar

3.0 ft/sec
 -50°F + 230°F
 6000 p.s.i.

MAXIMUM EXTRUSION GAP

PRESSURE bar
 MAXIMUM GAP mm
 PRESSURE p.s.i.
 MAXIMUM GAP in

Figures show the maximum permissible gap all on one side using minimum rod \varnothing and maximum clearance \varnothing .

160	250	400
0.6	0.5	0.4
2400	3750	6000
0.024	0.020	0.016

SURFACE ROUGHNESS

DYNAMIC SEALING FACE $\varnothing d_1$
 STATIC SEALING FACE $\varnothing D_1$
 STATIC HOUSING FACES L_1

μmRa	μmRt	μinCLA	μinRMS
0.1 ↔ 0.4	4 max	4 ↔ 16	5 ↔ 18
1.6 max	10 max	63 max	70 max
3.2 max	16 max	125 max	140 max

CHAMFERS & RADII

GROOVE SECTION S mm
 MIN CHAMFER C mm
 MAX FILLET RAD r_1 mm
 MAX FILLET RAD r_2 mm
 GROOVE SECTION S in
 MIN CHAMFER C in
 MAX FILLET RAD r_1 in
 MAX FILLET RAD r_2 in

4.0	5.0	7.5	10.0	12.5	15.0
3.0	3.5	5.0	6.5	7.0	8.0
0.2	0.4	0.8	0.8	1.2	1.6
0.4	0.8	1.2	1.2	1.6	2.4
0.125	0.187	0.250	0.312	0.375	0.500
0.093	0.093	0.125	0.156	0.187	0.217
0.008	0.008	0.016	0.032	0.032	0.032
0.016	0.016	0.032	0.047	0.047	0.047

TOLERANCES

$\varnothing d_1$	$\varnothing D_1$	L_1 mm	L_1 in
f9	Js11	+0.25 -0	+0.010 -0

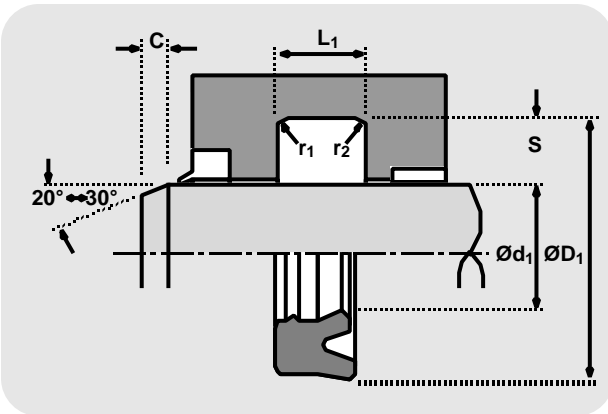

NB: Part numbers commencing 46 or suffixed by "†" are designed to suit popular Asian housings.

Part numbers suffixed by "‡" indicate housing sizes to meet ISO5597.

DESIGN

The Hallite 605 is an asymmetric seal offering superlative dry rod sealing for light and medium duty applications.

The 605 has become an industry standard seal worldwide owing to its twin lip profile and consistent performance.

Manufactured in Hythane® - 181, the Hallite 605 is an extremely flexible seal making installation very easy.

The ranges cover most standard housings used in Europe, North America and Asia.

FEATURES

- TWIN LIP DESIGN OFFERING: LOWER FRICTION, IMPROVED SEALING, PRIMARY LIP PROTECTION, INCREASED SEAL STABILITY.
- EASY INSTALLATION

Rod seals

Hallite 605

metric

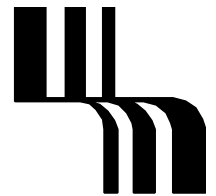
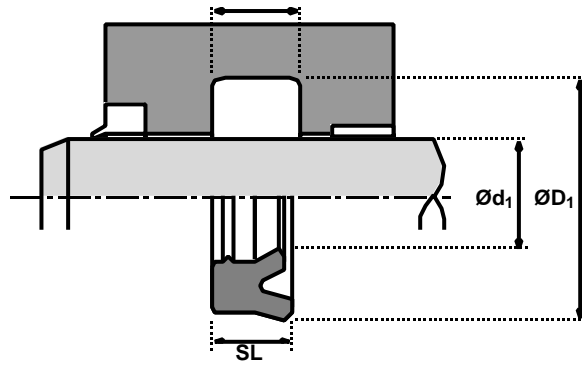

Ød ₁	TOL f9	ØD ₁	TOL Js11	SL	L ₁ +0.25 -0	PART No.
6	-0.016 -0.059	16	+0.06 -0.06	7.0	8.0	4580600
8	-0.016 -0.059	18	+0.06 -0.06	7.0	8.0	4580500
10	-0.016 -0.059	15	+0.06 -0.06	3.6	4.0	4402300
12	-0.016 -0.059	18	+0.06 -0.06	4.0	4.5	4578000
12	-0.016 -0.059	18	+0.06 -0.06	5.7	6.3	4314900
12	-0.016 -0.059	19	+0.07 -0.07	4.5	5.0	4341600
12	-0.016 -0.059	19	+0.07 -0.07	5.1	5.6	4710000
12	-0.016 -0.059	20	+0.07 -0.07	5.7	6.3	4310900‡
12	-0.016 -0.059	22	+0.07 -0.07	7.7	9.0	4315000
12.7	-0.016 -0.059	18	+0.06 -0.06	5.5	6.0	4370400
13	-0.016 -0.059	20	+0.07 -0.07	4.5	5.0	4351600
14	-0.016 -0.059	21	+0.07 -0.07	5.1	5.6	4710100
14	-0.016 -0.059	22	+0.07 -0.07	5.7	6.3	4311000‡
14	-0.016 -0.059	24	+0.07 -0.07	7.3	8.0	4310000‡
15.37	-0.016 -0.059	25.5	+0.07 -0.07	6.35	7.4	4333800
16	-0.016 -0.059	22	+0.07 -0.07	4.5	5.0	4341700
16	-0.016 -0.059	22	+0.07 -0.07	5.0	6.0	4314100
16	-0.016 -0.059	24	+0.07 -0.07	5.8	6.3	4295200‡
16	-0.016 -0.059	26	+0.07 -0.07	7.7	9.0	4311100
18	-0.016 -0.059	24	+0.07 -0.07	4.5	5.0	4712000
18	-0.016 -0.059	25	+0.07 -0.07	5.0	6.0	4314200
18	-0.016 -0.059	26	+0.07 -0.07	5.0	5.7	4611000
18	-0.016 -0.059	26	+0.07 -0.07	5.7	6.3	4311200‡

Ød ₁	TOL f9	ØD ₁	TOL Js11	SL	L ₁ +0.25 -0	PART No.
18	-0.016 -0.059	26	+0.07 -0.07	6.0	7.0	4333900
18	-0.016 -0.059	28	+0.07 -0.07	7.7	9.0	4305100
20	-0.020 -0.072	25	+0.07 -0.07	3.2	3.5	4332100
20	-0.020 -0.072	26	+0.07 -0.07	5.0	5.5	4315100
20	-0.020 -0.072	27	+0.07 -0.07	6.1	6.7	4702900
20	-0.020 -0.072	28	+0.07 -0.07	5.0	5.7	4611100
20	-0.020 -0.072	28	+0.07 -0.07	5.7	6.3	4362100‡
20	-0.020 -0.072	30	+0.07 -0.07	6.0	7.0	4611200
20	-0.020 -0.072	30	+0.07 -0.07	7.7	9.0	4305200
20	-0.020 -0.072	30	+0.07 -0.07	10.0	11.0	4310300
22	-0.020 -0.072	30	+0.07 -0.07	5.7	6.3	4305300‡
22	-0.020 -0.072	30	+0.07 -0.07	7.3	8.0	4356800
22	-0.020 -0.072	32	+0.08 -0.08	7.3	8.0	4310800‡
22	-0.020 -0.072	32	+0.08 -0.08	10.0	11.0	4311300
22.4	-0.020 -0.072	30	+0.08 -0.08	5.0	5.7	4611300
22.4	-0.020 -0.072	30	+0.08 -0.08	8.0	9.0	4616600
25	-0.020 -0.072	33	+0.08 -0.08	5.0	5.7	4610100
25	-0.020 -0.072	33	+0.08 -0.08	5.7	6.3	4305400‡
25	-0.020 -0.072	33	+0.08 -0.08	6.8	7.5	4333500
25	-0.020 -0.072	33	+0.08 -0.08	10.0	11.0	4315200
25	-0.020 -0.072	35	+0.08 -0.08	7.3	8.0	4512000‡
25	-0.020 -0.072	35	+0.08 -0.08	7.7	9.0	4311400
25	-0.020 -0.072	35	+0.08 -0.08	10.0	11.0	4310500

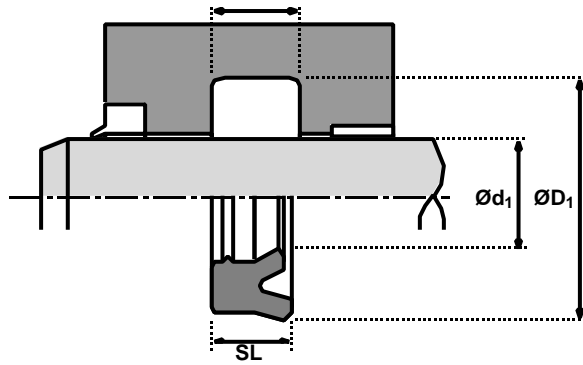
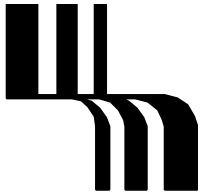

Rod seals

Hallite 605

metric

$\varnothing d_1$	TOL f9	$\varnothing D_1$	TOL Js11	SL	L_1 +0.25 -0	PART No.
25	-0.020 -0.072	37	+0.08 -0.08	10.0	11.0	4379900
25	-0.020 -0.072	40	+0.08 -0.08	10.0	11.0	4322900
26	-0.020 -0.072	36	+0.08 -0.08	7.0	8.0	4459400
28	-0.020 -0.072	35.5	+0.08 -0.08	5.0	5.7	4611400
28	-0.020 -0.072	36	+0.08 -0.08	5.7	6.3	4703000
28	-0.020 -0.072	38	+0.08 -0.08	7.3	8.0	4305500‡
28	-0.020 -0.072	43	+0.08 -0.08	11.4	12.5	4399000‡
30	-0.020 -0.072	38	+0.08 -0.08	5.7	6.3	4704500
30	-0.020 -0.072	38	+0.08 -0.08	6.3	7.0	4402700
30	-0.020 -0.072	40	+0.08 -0.08	6.0	7.0	4610200
30	-0.020 -0.072	40	+0.08 -0.08	7.0	7.7	4703100
30	-0.020 -0.072	40	+0.08 -0.08	10.0	11.0	4304600
30	-0.020 -0.072	42	+0.08 -0.08	10.9	12.0	4383100
30	-0.020 -0.072	50	+0.08 -0.08	10.0	11.0	4328500
32	-0.025 -0.087	40	+0.08 -0.08	6.0	7.0	4310700
32	-0.025 -0.087	40	+0.08 -0.08	6.7	7.7	4334000
32	-0.025 -0.087	40	+0.08 -0.08	7.7	9.0	4315300
32	-0.025 -0.087	41.5	+0.08 -0.08	7.9	8.9	4334100
32	-0.025 -0.087	42	+0.08 -0.08	5.7	6.3	4360100‡
32	-0.025 -0.087	42	+0.08 -0.08	6.0	7.0	4616100
32	-0.025 -0.087	42	+0.08 -0.08	7.3	8.0	4374200‡
32	-0.025 -0.087	42	+0.08 -0.08	10.0	11.0	4305600
32	-0.025 -0.087	45	+0.08 -0.08	10.0	11.0	4597700

$\varnothing d_1$	TOL f9	$\varnothing D_1$	TOL Js11	SL	L_1 +0.25 -0	PART No.
32	-0.025 -0.087	47	+0.08 -0.08	9.1	10.0	4329600
32	-0.025 -0.087	47	+0.08 -0.08	10.0	11.0	4338900
32	-0.025 -0.087	48	+0.08 -0.08	10.0	11.0	4492500
35	-0.025 -0.087	43	+0.08 -0.08	5.7	6.3	4703200
35	-0.025 -0.087	43	+0.08 -0.08	6.3	7.0	4402800
35	-0.025 -0.087	43	+0.08 -0.08	8.2	9.0	4309000
35	-0.025 -0.087	45	+0.08 -0.08	6.0	7.0	4611500
35	-0.025 -0.087	45	+0.08 -0.08	7.7	9.0	4314300
35	-0.025 -0.087	45	+0.08 -0.08	10.0	11.0	4305700
35	-0.025 -0.087	50	+0.08 -0.08	9.0	10.0	4611600
35	-0.025 -0.087	50	+0.08 -0.08	10.0	11.0	4322500
36	-0.025 -0.087	44	+0.08 -0.08	6.4	7.5	4373900
36	-0.025 -0.087	44	+0.08 -0.08	8.2	9.0	4395000
36	-0.025 -0.087	46	+0.08 -0.08	5.7	6.3	4372100‡
36	-0.025 -0.087	46	+0.08 -0.08	7.3	8.0	4304900‡
36	-0.025 -0.087	46	+0.08 -0.08	10.0	11.0	4305000
38	-0.025 -0.087	48	+0.08 -0.08	10.0	11.0	4515500
38	-0.025 -0.087	50	+0.08 -0.08	10.0	11.0	4586300
38	-0.025 -0.087	53	+0.08 -0.08	10.0	11.0	4480900
40	-0.025 -0.087	48	+0.08 -0.08	5.7	6.3	4703300
40	-0.025 -0.087	48	+0.08 -0.08	8.2	9.0	4396800
40	-0.025 -0.087	49.5	+0.08 -0.08	9.5	10.5	4334200
40	-0.025 -0.087	50	+0.08 -0.08	6.0	7.0	4610300

Rod seals

Hallite 605

metric

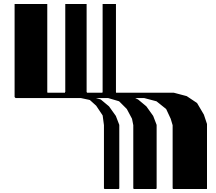
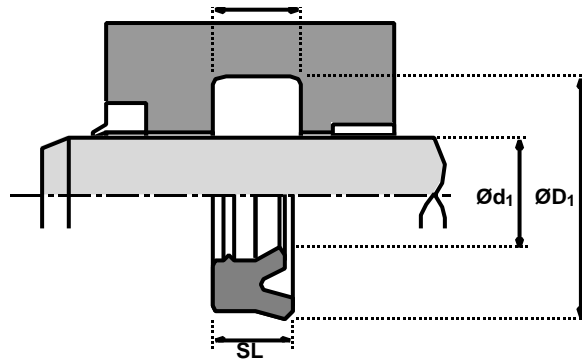

Ød ₁	TOL f9	ØD ₁	TOL Js11	SL	L ₁ +0.25 -0	PART No.
40	-0.025 -0.087	50	+0.08 -0.08	7.3	8.0	4311600‡
40	-0.025 -0.087	50	+0.08 -0.08	10.0	11.0	4293800
40	-0.025 -0.087	52	+0.10 -0.10	10.9	12.0	4381800
40	-0.025 -0.087	55	+0.10 -0.10	7.3	8.0	4703400
40	-0.025 -0.087	55	+0.10 -0.10	9.0	10.0	4611700
40	-0.025 -0.087	55	+0.10 -0.10	10.0	11.0	4328300
42	-0.025 -0.087	50	+0.08 -0.08	7.5	8.0	4373800
42	-0.025 -0.087	52	+0.08 -0.08	10.0	11.0	4338200
45	-0.025 -0.087	53	+0.10 -0.10	8.1	9.0	4402900
45	-0.025 -0.087	53	+0.10 -0.10	11.8	13.0	4315600
45	-0.025 -0.087	55	+0.10 -0.10	5.6	6.3	4479700‡
45	-0.025 -0.087	55	+0.10 -0.10	6.0	7.0	4610400
45	-0.025 -0.087	55	+0.10 -0.10	7.3	8.0	4305900‡
45	-0.025 -0.087	55	+0.10 -0.10	10.0	11.0	4302600
45	-0.025 -0.087	57.7	+0.10 -0.10	9.5	10.5	4322800
45	-0.025 -0.087	60	+0.10 -0.10	10.0	11.0	4315400
45	-0.025 -0.087	65	+0.10 -0.10	10.0	11.0	4315500
48	-0.025 -0.087	60	+0.10 -0.10	10.0	11.0	4432600
50	-0.025 -0.087	57	+0.10 -0.10	9.0	10.0	4538600
50	-0.025 -0.087	60	+0.10 -0.10	6.0	7.0	4611800
50	-0.025 -0.087	60	+0.10 -0.10	7.3	8.0	4306000‡
50	-0.025 -0.087	60	+0.10 -0.10	10.0	11.0	4304500
50	-0.025 -0.087	60	+0.10 -0.10	11.8	13.0	4314400

Ød ₁	TOL f9	ØD ₁	TOL Js11	SL	L ₁ +0.25 -0	PART No.
50	-0.025 -0.087	62.7	+0.10 -0.10	9.5	10.5	4334400
50	-0.025 -0.087	65	+0.10 -0.10	9.0	10.0	4611900
50	-0.025 -0.087	65	+0.10 -0.10	9.5	10.5	4344000
50	-0.025 -0.087	65	+0.10 -0.10	10.0	11.0	4617000
50	-0.025 -0.087	65	+0.10 -0.10	10.9	12.0	4291700
50	-0.025 -0.087	65	+0.10 -0.10	14.5	16.0	4381900
50	-0.025 -0.087	70	+0.10 -0.10	12.0	13.0	4612000
53	-0.030 -0.104	65	+0.10 -0.10	9.0	10.0	4371700
55	-0.030 -0.104	65	+0.10 -0.10	6.0	7.0	4615600
55	-0.030 -0.104	65	+0.10 -0.10	7.3	8.0	4703500
55	-0.030 -0.104	65	+0.10 -0.10	8.2	9.0	4360400
55	-0.030 -0.104	65	+0.10 -0.10	10.0	11.0	4306100
55	-0.030 -0.104	65	+0.10 -0.10	11.8	13.0	4323400
55	-0.030 -0.104	68	+0.10 -0.10	10.0	11.0	4593800
55	-0.030 -0.104	70	+0.10 -0.10	9.0	10.0	4612100
55	-0.030 -0.104	70	+0.10 -0.10	11.8	13.0	4319200
55	-0.030 -0.104	75	+0.10 -0.10	12.0	13.0	4612200
56	-0.030 -0.104	66	+0.10 -0.10	10.0	11.0	4311800
56	-0.030 -0.104	71	+0.10 -0.10	10.0	11.0	4311900
56	-0.030 -0.104	71	+0.10 -0.10	11.4	12.5	4306200‡
60	-0.030 -0.104	68	+0.10 -0.10	11.0	12.5	4538000
60	-0.030 -0.104	70	+0.10 -0.10	6.0	7.0	4610500
60	-0.030 -0.104	70	+0.10 -0.10	7.3	8.0	4703600

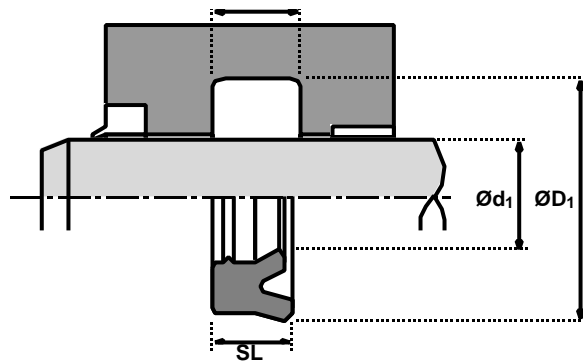
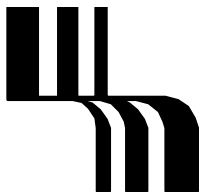

Rod seals

Hallite 605

metric

$\varnothing d_1$	TOL f9	$\varnothing D_1$	TOL Js11	SL	L_1 +0.25 -0	PART No.
60	-0.030 -0.104	70	+0.10 -0.10	10.0	11.0	4310600
60	-0.030 -0.104	70	+0.10 -0.10	11.8	13.0	4306300
60	-0.030 -0.104	71	+0.10 -0.10	7.0	8.0	4615700
60	-0.030 -0.104	72	+0.10 -0.10	10.0	11.0	4323500
60	-0.030 -0.104	73	+0.10 -0.10	10.0	11.0	4593900
60	-0.030 -0.104	75	+0.10 -0.10	9.0	10.0	4612300
60	-0.030 -0.104	75	+0.10 -0.10	10.0	11.0	4378700
60	-0.030 -0.104	75	+0.10 -0.10	11.8	13.0	4306400
60	-0.030 -0.104	75	+0.10 -0.10	20.5	22.5	4391800
60	-0.030 -0.104	80	+0.10 -0.10	11.4	12.5	4514300
60	-0.030 -0.104	80	+0.10 -0.10	12.0	13.0	4612400
63	-0.030 -0.104	73	+0.10 -0.10	6.0	7.0	4612500
63	-0.030 -0.104	73	+0.10 -0.10	11.8	13.0	4312000
63	-0.030 -0.104	78	+0.10 -0.10	10.0	11.0	4312100
63	-0.030 -0.104	78	+0.10 -0.10	11.4	12.5	4306500‡
65	-0.030 -0.104	75	+0.10 -0.10	6.0	7.0	4615900
65	-0.030 -0.104	75	+0.10 -0.10	7.7	9.0	4314500
65	-0.030 -0.104	75	+0.10 -0.10	11.8	13.0	4306600
65	-0.030 -0.104	77	+0.10 -0.10	9.0	10.0	4703700
65	-0.030 -0.104	77.7	+0.10 -0.10	9.5	10.5	4334500
65	-0.030 -0.104	78	+0.10 -0.10	10.0	11.0	4616200
65	-0.030 -0.104	80	+0.10 -0.10	9.0	10.0	4612600
65	-0.030 -0.104	80	+0.10 -0.10	11.8	13.0	4312200

$\varnothing d_1$	TOL f9	$\varnothing D_1$	TOL Js11	SL	L_1 +0.25 -0	PART No.
65	-0.030 -0.104	85	+0.10 -0.10	12.0	13.0	4612700
67	-0.030 -0.104	77	+0.10 -0.10	6.0	7.0	4612800
70	-0.030 -0.104	80	+0.10 -0.10	6.0	7.0	4615800
70	-0.030 -0.104	80	+0.10 -0.10	11.8	13.0	4312300
70	-0.030 -0.104	82	+0.11 -0.11	8.7	9.6	4494700
70	-0.030 -0.104	82	+0.11 -0.11	10.0	11.0	4323600
70	-0.030 -0.104	83	+0.11 -0.11	10.0	11.0	4616400
70	-0.030 -0.104	85	+0.11 -0.11	9.0	10.0	4612900
70	-0.030 -0.104	85	+0.11 -0.11	10.0	11.0	4302700
70	-0.030 -0.104	85	+0.11 -0.11	11.4	12.5	4301200‡
70	-0.030 -0.104	85	+0.11 -0.11	20.5	22.5	4401400
70	-0.030 -0.104	90	+0.11 -0.11	12.0	13.0	4613000
75	-0.030 -0.104	83	+0.11 -0.11	11.4	12.5	4706300
75	-0.030 -0.104	85	+0.11 -0.11	6.0	7.0	4616800
75	-0.030 -0.104	85	+0.11 -0.11	11.8	13.0	4312400
75	-0.030 -0.104	88	+0.11 -0.11	10.0	11.0	4616300
75	-0.030 -0.104	90	+0.11 -0.11	9.0	10.0	4613100
75	-0.030 -0.104	95	+0.11 -0.11	12.0	13.0	4613200
78	-0.030 -0.104	86	+0.11 -0.11	9.0	10.0	4538700
80	-0.030 -0.104	90	+0.11 -0.11	6.0	7.0	4616000
80	-0.030 -0.104	90	+0.11 -0.11	10.0	11.0	4390400
80	-0.030 -0.104	90	+0.11 -0.11	11.8	13.0	4312500
80	-0.030 -0.104	92	+0.11 -0.11	8.7	9.6	4494800

Rod seals

Hallite 605

metric

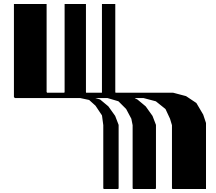
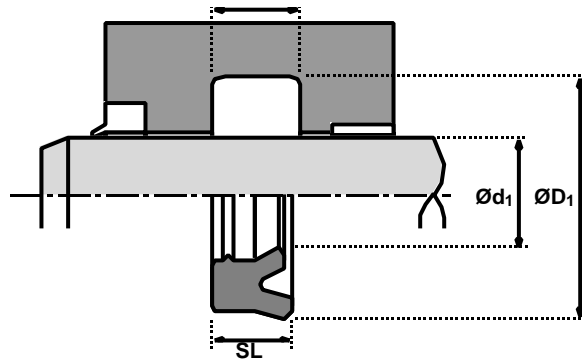

Ød ₁	TOL f9	ØD ₁	TOL Js11	SL	L ₁ +0.25 -0	PART No.
80	-0.030 -0.104	93	+0.11 -0.11	10.0	11.0	4615200
80	-0.030 -0.104	95	+0.11 -0.11	9.0	10.0	4613300
80	-0.030 -0.104	95	+0.11 -0.11	10.0	11.0	4383500
80	-0.030 -0.104	95	+0.11 -0.11	11.8	13.0	4306700
80	-0.030 -0.104	100	+0.11 -0.11	12.0	13.0	4613400
80	-0.030 -0.104	100	+0.11 -0.11	14.5	16.0	4382800‡
80	-0.030 -0.104	110	+0.11 -0.11	16.4	18.0	4342900
85	-0.036 -0.123	93	+0.11 -0.11	10.0	11.0	4392700
85	-0.036 -0.123	93	+0.11 -0.11	11.0	12.5	4537900
85	-0.036 -0.123	100	+0.11 -0.11	9.0	10.0	4610600
85	-0.036 -0.123	100	+0.11 -0.11	10.0	11.0	4615300
85	-0.036 -0.123	100	+0.11 -0.11	11.8	13.0	4306800
85	-0.036 -0.123	105	+0.11 -0.11	12.0	13.0	4613500
90	-0.036 -0.123	98	+0.11 -0.11	11.4	12.5	4706400
90	-0.036 -0.123	100	+0.11 -0.11	6.8	7.5	4493500‡
90	-0.036 -0.123	100	+0.11 -0.11	9.0	10.0	4366900
90	-0.036 -0.123	100	+0.11 -0.11	11.8	13.0	4314600
90	-0.036 -0.123	102	+0.11 -0.11	8.7	9.6	4333000
90	-0.036 -0.123	105	+0.11 -0.11	9.0	10.0	4613600
90	-0.036 -0.123	105	+0.11 -0.11	10.0	11.0	4615400
90	-0.036 -0.123	105	+0.11 -0.11	11.4	12.5	4306900‡
90	-0.036 -0.123	110	+0.11 -0.11	12.0	13.0	4613700
95	-0.036 -0.123	110	+0.11 -0.11	9.0	10.0	4610700

Ød ₁	TOL f9	ØD ₁	TOL Js11	SL	L ₁ +0.25 -0	PART No.
95	-0.036 -0.123	110	+0.11 -0.11	10.0	11.0	4615500
95	-0.036 -0.123	115	+0.11 -0.11	12.0	13.0	4613800
96	-0.036 -0.123	104	+0.11 -0.11	10.9	12.0	4380300
100	-0.036 -0.123	110	+0.11 -0.11	10.9	12.0	4461700
100	-0.036 -0.123	115	+0.11 -0.11	9.0	10.0	4610800
100	-0.036 -0.123	115	+0.11 -0.11	10.0	11.0	4617100
100	-0.036 -0.123	115	+0.11 -0.11	11.8	13.0	4312600
100	-0.036 -0.123	120	+0.11 -0.11	11.8	13.0	4312700†
100	-0.036 -0.123	120	+0.11 -0.11	14.5	16.0	4307000‡
105	-0.036 -0.123	113	+0.11 -0.11	10.0	11.0	4392800
105	-0.036 -0.123	115	+0.11 -0.11	13.2	14.5	4390500
105	-0.036 -0.123	120	+0.11 -0.11	10.0	11.0	4617200
105	-0.036 -0.123	120	+0.11 -0.11	14.5	16.0	4379500
108	-0.036 -0.123	123	+0.13 -0.13	10.9	12.0	4329100
110	-0.036 -0.123	125	+0.13 -0.13	9.0	10.0	4459700†
110	-0.036 -0.123	125	+0.13 -0.13	11.0	12.0	4537800
110	-0.036 -0.123	125	+0.13 -0.13	14.5	16.0	4481600
110	-0.036 -0.123	130	+0.13 -0.13	11.8	13.0	4312800†
110	-0.036 -0.123	130	+0.13 -0.13	14.5	16.0	4307100‡
110	-0.036 -0.123	135	+0.13 -0.13	14.5	16.0	4343000
112	-0.036 -0.123	125	+0.13 -0.13	9.0	10.0	4610900
115	-0.036 -0.123	130	+0.13 -0.13	9.0	10.0	4459800
115	-0.036 -0.123	130	+0.13 -0.13	10.9	12.0	4434600

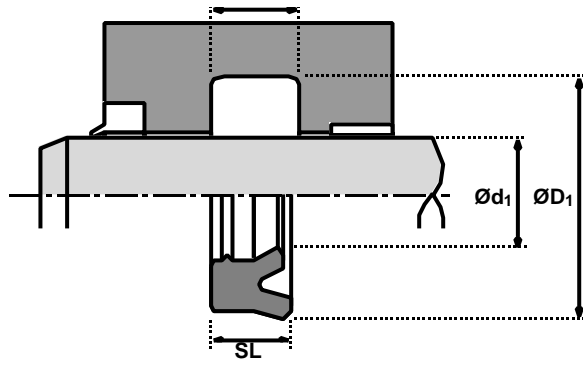
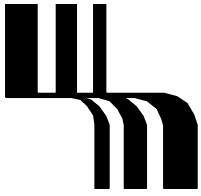

Rod seals

Hallite 605

metric

$\varnothing d_1$	TOL f9	$\varnothing D_1$	TOL Js11	SL	L_1 +0.25 -0	PART No.
115	-0.036 -0.123	130	+0.13 -0.13	14.5	16.0	4342600
120	-0.036 -0.123	128	+0.13 -0.13	11.4	12.5	4706500
120	-0.036 -0.123	130	+0.13 -0.13	10.9	12.0	4461800
120	-0.036 -0.123	135	+0.13 -0.13	9.0	10.0	4614000
120	-0.036 -0.123	140	+0.13 -0.13	12.0	13.0	4614100
120	-0.036 -0.123	140	+0.13 -0.13	14.5	16.0	4312900
125	-0.043 -0.143	133	+0.13 -0.13	10.0	11.0	4392900
125	-0.043 -0.143	140	+0.13 -0.13	9.0	10.0	4614200
125	-0.043 -0.143	145	+0.13 -0.13	12.0	13.0	4614300
125	-0.043 -0.143	145	+0.13 -0.13	14.5	16.0	4307300†
125	-0.043 -0.143	150	+0.13 -0.13	12.5	14.0	4367000
130	-0.043 -0.143	140	+0.13 -0.13	14.5	16.0	4390600
130	-0.043 -0.143	145	+0.13 -0.13	9.0	10.0	4614400
130	-0.043 -0.143	150	+0.13 -0.13	12.0	13.0	4614500
130	-0.043 -0.143	150	+0.13 -0.13	14.5	16.0	4313000
132.5	-0.043 -0.143	157.5	+0.13 -0.13	13.2	14.5	4329400
135	-0.043 -0.143	150	+0.13 -0.13	11.0	12.5	4537700
140	-0.043 -0.143	150	+0.13 -0.13	10.9	12.0	4461900
140	-0.043 -0.143	155	+0.13 -0.13	9.0	10.0	4614600
140	-0.043 -0.143	155	+0.13 -0.13	11.8	13.0	4555300
140	-0.043 -0.143	160	+0.13 -0.13	11.8	13.0	4313100†
140	-0.043 -0.143	160	+0.13 -0.13	14.5	16.0	4307400†

$\varnothing d_1$	TOL f9	$\varnothing D_1$	TOL Js11	SL	L_1 +0.25 -0	PART No.
150	-0.043 -0.143	160	+0.13 -0.13	11.0	12.0	4595200‡
150	-0.043 -0.143	165	+0.13 -0.13	9.0	10.0	4614700
150	-0.043 -0.143	170	+0.13 -0.13	12.0	13.0	4614800
150	-0.043 -0.143	170	+0.13 -0.13	13.2	14.5	4367100
150	-0.043 -0.143	170	+0.13 -0.13	14.5	16.0	4342800
151	-0.043 -0.143	159	+0.13 -0.13	9.0	10.0	4538800
155	-0.043 -0.143	170	+0.13 -0.13	14.5	16.0	4342700
160	-0.043 -0.143	175	+0.13 -0.13	9.0	10.0	4614900
160	-0.043 -0.143	175	+0.13 -0.13	10.9	12.0	4462000
160	-0.043 -0.143	180	+0.13 -0.13	12.0	13.0	4615000
160	-0.043 -0.143	180	+0.13 -0.13	14.5	16.0	4345000
165	-0.043 -0.143	180	+0.13 -0.13	9.0	10.0	4616500
170	-0.043 -0.143	190	+0.15 -0.15	14.5	16.0	4398800
180	-0.043 -0.143	200	+0.15 -0.15	11.8	13.0	4314700†
180	-0.043 -0.143	200	+0.15 -0.15	14.5	16.0	4560900
185	-0.050 -0.165	200	+0.15 -0.15	10.9	12.0	4462100
200	-0.050 -0.165	220	+0.15 -0.15	12.0	13.0	4615100
200	-0.050 -0.165	220	+0.15 -0.15	14.5	16.0	4380200
205	-0.050 -0.165	220	+0.15 -0.15	12.2	13.5	4522400
220	-0.050 -0.165	240	+0.15 -0.15	14.5	16.0	4555400
330	-0.062 -0.212	350	+0.18 -0.18	18.2	20.0	4587400

Rod seals

Hallite 605

inch

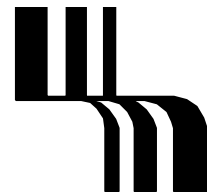
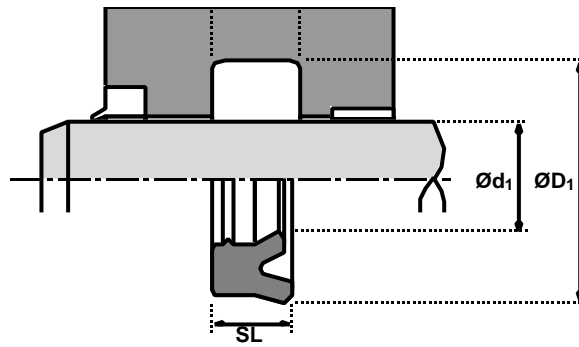

Ød ₁	TOL f9	ØD ₁	TOL Js11	SL	L ₁ +0.25 -0	PART No.
0.375	-0.0005 -0.0019	0.625	+0.002 -0.002	0.198	0.218	4544300
0.375	-0.0005 -0.0019	0.750	+0.003 -0.003	0.312	0.343	4710500
0.500	-0.0006 -0.0023	0.750	+0.003 -0.003	0.187	0.207	4576100
0.562	-0.0006 -0.0023	0.813	+0.003 -0.003	0.187	0.207	4576200
0.625	-0.0006 -0.0023	0.875	+0.003 -0.003	0.187	0.207	4493700
0.625	-0.0006 -0.0023	0.875	+0.003 -0.003	0.241	0.265	4329000
0.625	-0.0006 -0.0023	1.000	+0.003 -0.003	0.281	0.312	4447200
0.687	-0.0006 -0.0023	0.937	+0.003 -0.003	0.187	0.207	4572000
0.750	-0.0008 -0.0028	1.000	+0.003 -0.003	0.125	0.138	4552900
0.750	-0.0008 -0.0028	1.000	+0.003 -0.003	0.187	0.207	4571000
0.750	-0.0008 -0.0028	1.000	+0.003 -0.003	0.250	0.275	4345100
0.750	-0.0008 -0.0028	1.125	+0.003 -0.003	0.312	0.344	4512200
0.812	-0.0008 -0.0028	1.062	+0.003 -0.003	0.250	0.275	4558700
0.812	-0.0008 -0.0028	1.062	+0.003 -0.003	0.187	0.207	4576300
0.875	-0.0008 -0.0028	1.125	+0.003 -0.003	0.187	0.207	4576400
0.875	-0.0008 -0.0028	1.125	+0.003 -0.003	0.250	0.275	4442500
0.875	-0.0008 -0.0028	1.375	+0.003 -0.003	0.341	0.375	4373100
1.000	-0.0008 -0.0028	1.240	+0.003 -0.003	0.187	0.211	4371800
1.000	-0.0008 -0.0028	1.250	+0.003 -0.003	0.187	0.207	4442600
1.000	-0.0008 -0.0028	1.250	+0.003 -0.003	0.250	0.275	4345200
1.000	-0.0008 -0.0028	1.312	+0.003 -0.003	0.219	0.241	4493800
1.000	-0.0008 -0.0028	1.375	+0.003 -0.003	0.250	0.275	4456800
1.000	-0.0008 -0.0028	1.375	+0.003 -0.003	0.312	0.344	4345900
1.000	-0.0008 -0.0028	1.500	+0.003 -0.003	0.255	0.275	4430200

Ød ₁	TOL f9	ØD ₁	TOL Js11	SL	L ₁ +0.25 -0	PART No.
1.000	-0.0008 -0.0028	1.500	+0.003 -0.003	0.341	0.375	4330100
1.000	-0.0008 -0.0028	1.500	+0.003 -0.003	0.375	0.413	4308400
1.062	-0.0008 -0.0028	1.302	+0.003 -0.003	0.187	0.203	4410300
1.062	-0.0008 -0.0028	1.312	+0.003 -0.003	0.250	0.275	4394500
1.125	-0.0008 -0.0028	1.365	+0.003 -0.003	0.192	0.211	4384500
1.125	-0.0008 -0.0028	1.375	+0.003 -0.003	0.187	0.207	4442700
1.125	-0.0008 -0.0028	1.375	+0.003 -0.003	0.250	0.275	4388000
1.125	-0.0008 -0.0028	1.399	+0.003 -0.003	0.187	0.211	4371900
1.125	-0.0008 -0.0028	1.500	+0.003 -0.003	0.312	0.344	4392600
1.125	-0.0008 -0.0028	1.562	+0.003 -0.003	0.325	0.360	4568800
1.125	-0.0008 -0.0028	1.625	+0.003 -0.003	0.250	0.275	4370900
1.125	-0.0008 -0.0028	1.750	+0.003 -0.003	0.397	0.437	4373000
1.187	-0.0008 -0.0028	1.562	+0.003 -0.003	0.250	0.275	4458600
1.250	-0.0010 -0.0034	1.500	+0.003 -0.003	0.250	0.275	4345300
1.250	-0.0010 -0.0034	1.625	+0.003 -0.003	0.187	0.207	4552600
1.250	-0.0010 -0.0034	1.625	+0.003 -0.003	0.227	0.250	4330200
1.250	-0.0010 -0.0034	1.625	+0.003 -0.003	0.250	0.275	4460600
1.250	-0.0010 -0.0034	1.625	+0.003 -0.003	0.312	0.344	4346000
1.250	-0.0010 -0.0034	1.750	+0.003 -0.003	0.250	0.275	4513500
1.250	-0.0010 -0.0034	1.750	+0.003 -0.003	0.375	0.413	4335800
1.250	-0.0010 -0.0034	1.875	+0.003 -0.003	0.397	0.437	4330300
1.375	-0.0010 -0.0034	1.625	+0.003 -0.003	0.250	0.275	4345400
1.375	-0.0010 -0.0034	1.687	+0.003 -0.003	0.219	0.241	4493900
1.375	-0.0010 -0.0034	1.750	+0.003 -0.003	0.187	0.207	4552800

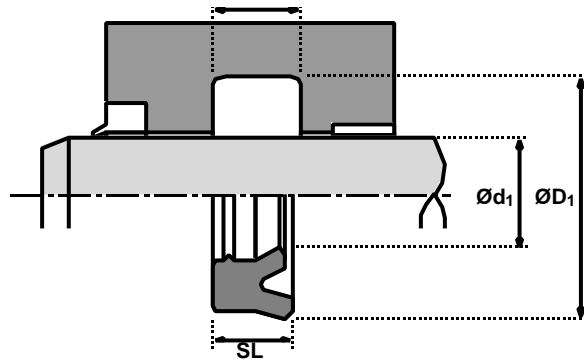
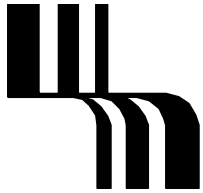

Rod seals

Hallite 605

inch

$\varnothing d_1$	TOL f9	$\varnothing D_1$	TOL Js11	SL	L_1 +0.010 -0	PART No.
1.375	-0.0010 -0.0034	1.750	+0.003 -0.003	0.312	0.344	4346100
1.375	-0.0010 -0.0034	1.875	+0.003 -0.003	0.375	0.413	4403100
1.375	-0.0010 -0.0034	2.000	+0.004 -0.004	0.397	0.437	4330400
1.437	-0.0010 -0.0034	1.812	+0.003 -0.003	0.312	0.344	4442800
1.500	-0.0010 -0.0034	1.750	+0.003 -0.003	0.250	0.275	4345500
1.500	-0.0010 -0.0034	1.875	+0.003 -0.003	0.187	0.207	4576600
1.500	-0.0010 -0.0034	1.875	+0.003 -0.003	0.250	0.275	4322100
1.500	-0.0010 -0.0034	1.875	+0.003 -0.003	0.312	0.344	4346200
1.500	-0.0010 -0.0034	1.875	+0.003 -0.003	0.375	0.413	4385400
1.500	-0.0010 -0.0034	2.000	+0.004 -0.004	0.250	0.275	4394400
1.500	-0.0010 -0.0034	2.000	+0.004 -0.004	0.341	0.375	4330500
1.500	-0.0010 -0.0034	2.000	+0.004 -0.004	0.375	0.413	4322200
1.500	-0.0010 -0.0034	2.125	+0.004 -0.004	0.375	0.413	4442900
1.500	-0.0010 -0.0034	2.125	+0.004 -0.004	0.397	0.437	4330600
1.625	-0.0010 -0.0034	1.875	+0.003 -0.003	0.250	0.275	4345600
1.625	-0.0010 -0.0034	2.000	+0.004 -0.004	0.281	0.312	4542800
1.625	-0.0010 -0.0034	2.000	+0.004 -0.004	0.312	0.344	4443000
1.625	-0.0010 -0.0034	2.000	+0.004 -0.004	0.375	0.413	4443100
1.625	-0.0010 -0.0034	2.125	+0.004 -0.004	0.375	0.413	4512100
1.750	-0.0010 -0.0034	2.000	+0.004 -0.004	0.250	0.275	4345700
1.750	-0.0010 -0.0034	2.125	+0.004 -0.004	0.250	0.275	4357200
1.750	-0.0010 -0.0034	2.125	+0.004 -0.004	0.312	0.344	4346300
1.750	-0.0010 -0.0034	2.125	+0.004 -0.004	0.375	0.413	4366800
1.750	-0.0010 -0.0034	2.250	+0.004 -0.004	0.250	0.275	4552700

$\varnothing d_1$	TOL f9	$\varnothing D_1$	TOL Js11	SL	L_1 +0.010 -0	PART No.
1.750	-0.0010 -0.0034	2.250	+0.004 -0.004	0.341	0.375	4330700
1.750	-0.0010 -0.0034	2.250	+0.004 -0.004	0.375	0.413	4337000
1.750	-0.0010 -0.0034	2.250	+0.004 -0.004	0.500	0.550	4376800
1.750	-0.0010 -0.0034	2.375	+0.004 -0.004	0.437	0.481	4443200
1.875	-0.0010 -0.0034	2.250	+0.004 -0.004	0.375	0.413	4476200
1.875	-0.0010 -0.0034	2.375	+0.004 -0.004	0.375	0.413	4391200
1.875	-0.0010 -0.0034	2.500	+0.004 -0.004	0.397	0.437	4331500
2.000	-0.0012 -0.0041	2.250	+0.004 -0.004	0.250	0.275	4345800
2.000	-0.0012 -0.0041	2.375	+0.004 -0.004	0.250	0.275	4458700
2.000	-0.0012 -0.0041	2.375	+0.004 -0.004	0.312	0.344	4346400
2.000	-0.0012 -0.0041	2.375	+0.004 -0.004	0.375	0.413	4380100
2.000	-0.0012 -0.0041	2.500	+0.004 -0.004	0.250	0.275	4496900
2.000	-0.0012 -0.0041	2.500	+0.004 -0.004	0.312	0.344	4382900
2.000	-0.0012 -0.0041	2.500	+0.004 -0.004	0.341	0.375	4330900
2.000	-0.0012 -0.0041	2.500	+0.004 -0.004	0.375	0.413	4337100
2.000	-0.0012 -0.0041	2.500	+0.004 -0.004	0.781	0.859	4491400
2.000	-0.0012 -0.0041	2.625	+0.004 -0.004	0.312	0.344	4333100
2.000	-0.0012 -0.0041	2.625	+0.004 -0.004	0.397	0.437	4331000
2.000	-0.0012 -0.0041	2.625	+0.004 -0.004	0.500	0.550	4346500
2.000	-0.0012 -0.0041	2.750	+0.004 -0.004	0.625	0.688	4347300
2.125	-0.0012 -0.0041	2.500	+0.004 -0.004	0.375	0.413	4443300
2.250	-0.0012 -0.0041	2.625	+0.004 -0.004	0.335	0.375	4372200
2.250	-0.0012 -0.0041	2.750	+0.004 -0.004	0.341	0.375	4331100
2.250	-0.0012 -0.0041	2.750	+0.004 -0.004	0.375	0.413	4337200

Rod seals

Hallite 605

inch

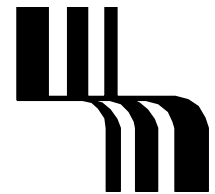
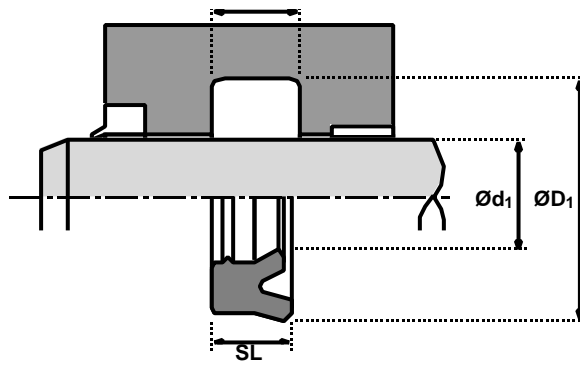

Ød ₁	TOL f ₉	ØD ₁	TOL Js11	SL	L ₁ +0.25 -0	PART No.
2.250	-0.0012 -0.0041	3.000	+0.004 -0.004	0.511	0.562	4331200
2.375	-0.0012 -0.0041	2.750	+0.004 -0.004	0.375	0.413	4443400
2.375	-0.0012 -0.0041	2.875	+0.004 -0.004	0.375	0.413	4443500
2.500	-0.0012 -0.0041	2.875	+0.004 -0.004	0.312	0.344	4443600
2.500	-0.0012 -0.0041	2.875	+0.004 -0.004	0.375	0.413	4458500
2.500	-0.0012 -0.0041	2.937	+0.004 -0.004	0.284	0.312	4535900
2.500	-0.0012 -0.0041	3.000	+0.004 -0.004	0.250	0.275	4553000
2.500	-0.0012 -0.0041	3.000	+0.004 -0.004	0.284	0.312	4331300
2.500	-0.0012 -0.0041	3.000	+0.004 -0.004	0.375	0.413	4335900
2.500	-0.0012 -0.0041	3.125	+0.004 -0.004	0.500	0.550	4346600
2.500	-0.0012 -0.0041	3.250	+0.004 -0.004	0.625	0.688	4347400
2.625	-0.0012 -0.0041	3.000	+0.004 -0.004	0.375	0.413	4443700
2.625	-0.0012 -0.0041	3.125	+0.004 -0.004	0.500	0.550	4514900
2.625	-0.0012 -0.0041	3.250	+0.004 -0.004	0.625	0.688	4376900
2.750	-0.0012 -0.0041	3.125	+0.004 -0.004	0.375	0.413	4379100
2.750	-0.0012 -0.0041	3.250	+0.004 -0.004	0.375	0.413	4336000
2.750	-0.0012 -0.0041	3.375	+0.004 -0.004	0.375	0.413	4456900
2.750	-0.0012 -0.0041	3.375	+0.004 -0.004	0.500	0.550	4346700
2.750	-0.0012 -0.0041	3.375	+0.004 -0.004	0.805	0.885	4467400
2.750	-0.0012 -0.0041	3.500	+0.004 -0.004	0.625	0.688	4347500
2.875	-0.0012 -0.0041	3.250	+0.004 -0.004	0.375	0.413	4443800
3.000	-0.0012 -0.0041	3.375	+0.004 -0.004	0.375	0.413	4468300
3.000	-0.0012 -0.0041	3.438	+0.004 -0.004	0.281	0.310	4539900
3.000	-0.0012 -0.0041	3.500	+0.004 -0.004	0.375	0.413	4336100

Ød ₁	TOL f ₉	ØD ₁	TOL Js11	SL	L ₁ +0.25 -0	PART No.
3.000	-0.0012 -0.0041	3.500	+0.004 -0.004	0.625	0.688	4399600
3.000	-0.0012 -0.0041	3.500	+0.004 -0.004	0.781	0.859	4476900
3.000	-0.0012 -0.0041	3.625	+0.004 -0.004	0.500	0.550	4346800
3.000	-0.0012 -0.0041	3.750	+0.004 -0.004	0.625	0.688	4347600
3.125	-0.0012 -0.0041	3.500	+0.004 -0.004	0.625	0.688	4399700
3.250	-0.0014 -0.0048	3.625	+0.004 -0.004	0.375	0.413	4714100
3.250	-0.0014 -0.0048	3.625	+0.004 -0.004	0.562	0.619	4476800
3.250	-0.0014 -0.0048	3.750	+0.004 -0.004	0.375	0.413	4336200
3.250	-0.0014 -0.0048	3.875	+0.004 -0.004	0.500	0.550	4415400
3.375	-0.0014 -0.0048	4.000	+0.004 -0.004	0.594	0.653	4377000
3.500	-0.0014 -0.0048	3.875	+0.004 -0.004	0.375	0.413	4468400
3.500	-0.0014 -0.0048	4.000	+0.004 -0.004	0.312	0.344	4540000
3.500	-0.0014 -0.0048	4.000	+0.004 -0.004	0.375	0.413	4336300
3.500	-0.0014 -0.0048	4.125	+0.004 -0.004	0.500	0.550	4346900
3.500	-0.0014 -0.0048	4.250	+0.004 -0.004	0.625	0.688	4347700
3.625	-0.0014 -0.0048	4.125	+0.004 -0.004	0.375	0.413	4436200
3.750	-0.0014 -0.0048	4.125	+0.004 -0.004	0.375	0.413	4702500
3.750	-0.0014 -0.0048	4.250	+0.004 -0.004	0.375	0.413	4443900
3.750	-0.0014 -0.0048	4.250	+0.004 -0.004	0.500	0.550	4456500
3.750	-0.0014 -0.0048	4.250	+0.004 -0.004	0.562	0.625	4436100
4.000	-0.0014 -0.0048	4.375	+0.004 -0.004	0.375	0.413	4468500
4.000	-0.0014 -0.0048	4.500	+0.004 -0.004	0.312	0.355	4586700
4.000	-0.0014 -0.0048	4.500	+0.004 -0.004	0.375	0.413	4336400
4.000	-0.0014 -0.0048	4.500	+0.004 -0.004	0.562	0.619	4385700

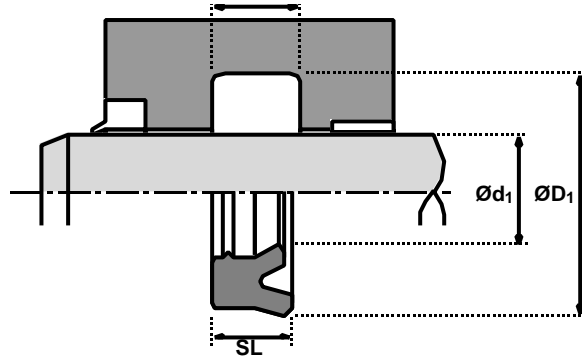
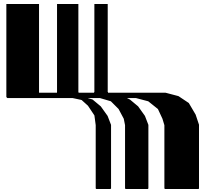

Rod seals
Hallite
605
 inch

$\varnothing d_1$	TOL f9	$\varnothing D_1$	TOL Js11	SL	L_1 +0.010 -0	PART No.
4.000	-0.0014 -0.0048	4.500	+0.004 -0.004	0.781	0.859	4399800
4.000	-0.0014 -0.0048	4.625	+0.004 -0.004	0.375	0.413	4520100
4.000	-0.0014 -0.0048	4.625	+0.004 -0.004	0.500	0.550	4347000
4.000	-0.0014 -0.0048	4.750	+0.004 -0.004	0.500	0.550	4444000
4.000	-0.0014 -0.0048	4.750	+0.005 -0.005	0.625	0.688	4347800
4.250	-0.0014 -0.0048	5.000	+0.005 -0.005	0.625	0.688	4347900
4.500	-0.0014 -0.0048	5.000	+0.005 -0.005	0.375	0.413	4379200
4.500	-0.0014 -0.0048	5.125	+0.005 -0.005	0.500	0.550	4347100
4.500	-0.0014 -0.0048	5.125	+0.005 -0.005	0.625	0.688	4444100
4.500	-0.0014 -0.0048	5.250	+0.005 -0.005	0.625	0.688	4348000
4.625	-0.0014 -0.0048	5.250	+0.005 -0.005	0.625	0.688	4377100
4.750	-0.0014 -0.0048	5.125	+0.005 -0.005	0.375	0.413	4714200
4.750	-0.0014 -0.0048	5.250	+0.005 -0.005	0.625	0.688	4451100
5.000	-0.0017 -0.0056	5.500	+0.005 -0.005	0.375	0.413	4495000
5.000	-0.0017 -0.0056	5.500	+0.005 -0.005	0.562	0.619	4386100
5.000	-0.0017 -0.0056	5.500	+0.005 -0.005	0.781	0.859	4399900
5.000	-0.0017 -0.0056	5.531	+0.005 -0.005	0.557	0.619	4391400
5.000	-0.0017 -0.0056	5.625	+0.005 -0.005	0.500	0.550	4347200
5.000	-0.0017 -0.0056	5.750	+0.005 -0.005	0.625	0.688	4348100
5.125	-0.0017 -0.0056	5.625	+0.005 -0.005	0.562	0.619	4436000
5.125	-0.0017 -0.0056	6.000	+0.005 -0.005	0.500	0.550	4444200
5.375	-0.0017 -0.0056	5.875	+0.005 -0.005	0.625	0.688	4475800
5.375	-0.0017 -0.0056	6.000	+0.005 -0.005	0.625	0.688	4448300

$\varnothing d_1$	TOL f9	$\varnothing D_1$	TOL Js11	SL	L_1 +0.010 -0	PART No.
5.500	-0.0017 -0.0056	6.000	+0.005 -0.005	0.375	0.413	4379300
5.500	-0.0017 -0.0056	6.000	+0.005 -0.005	0.562	0.619	4468600
5.500	-0.0017 -0.0056	6.125	+0.005 -0.005	0.312	0.344	4540100
5.500	-0.0017 -0.0056	6.250	+0.005 -0.005	0.625	0.688	4348200
5.625	-0.0017 -0.0056	6.125	+0.005 -0.005	0.375	0.413	4714300
6.000	-0.0017 -0.0056	6.500	+0.005 -0.005	0.562	0.619	4436500
6.000	-0.0017 -0.0056	6.500	+0.005 -0.005	0.781	0.859	4400000
6.000	-0.0017 -0.0056	6.531	+0.005 -0.005	0.562	0.619	4391000
6.000	-0.0017 -0.0056	6.750	+0.005 -0.005	0.625	0.688	4348300
6.500	-0.0017 -0.0056	7.250	+0.006 -0.006	0.625	0.688	4348400
7.000	-0.0017 -0.0056	7.500	+0.006 -0.006	0.562	0.619	4436600
7.000	-0.0017 -0.0056	7.500	+0.006 -0.006	0.780	0.859	4456600
7.000	-0.0017 -0.0056	7.531	+0.006 -0.006	0.562	0.619	4391100
7.000	-0.0017 -0.0056	7.750	+0.006 -0.006	0.625	0.688	4348500
7.500	-0.0017 -0.0056	8.000	+0.006 -0.006	0.375	0.413	4714400
7.750	-0.0020 -0.0065	8.500	+0.006 -0.006	0.625	0.688	4353900
8.000	-0.0020 -0.0065	8.500	+0.006 -0.006	0.562	0.619	4468700
8.000	-0.0020 -0.0065	8.750	+0.006 -0.006	0.625	0.688	4510500
8.125	-0.0020 -0.0065	8.625	+0.006 -0.006	0.781	0.859	4477000
9.000	-0.0020 -0.0065	9.500	+0.006 -0.006	0.562	0.619	4468800
9.250	-0.0020 -0.0065	10.000	+0.006 -0.006	0.625	0.688	4499300
9.375	-0.0020 -0.0065	9.875	+0.006 -0.006	0.781	0.859	4477100
10.000	-0.0022 -0.0073	10.500	+0.006 -0.006	0.562	0.619	4468900

Notes

