

Rod Seals

Hallite

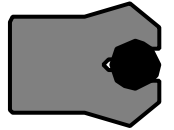

513

TECHNICAL DETAILS		METRIC	INCH	
OPERATING CONDITIONS				
MAXIMUM SPEED	0.5 m/sec	1.5 ft/sec		
TEMPERATURE RANGE	-40°C + 110°C	-40°F + 230°F		
MAXIMUM PRESSURE	350 bar	5000 p.s.i.		
MAXIMUM EXTRUSION GAP				
(1/4" section and above)				
PRESSURE bar	160	250	350	
PRESSURE p.s.i.	2400	3750	5000	
MAXIMUM GAP in	0.024	0.020	0.016	
SURFACE ROUGHNESS				
DYNAMIC SEALING FACE ϕd_1	μmRa 0.1 ↔ 0.4	μmRt 4 max	μinCLA 4 ↔ 16	μinRMS 5 ↔ 18
STATIC SEALING FACE ϕD_1	1.6 max	10 max	63 max	70 max
STATIC HOUSING FACES L_1	3.2 max	16 max	125 max	140 max
CHAMFERS & RADII				
GROOVE SECTION S in	0.125	0.187	0.250	0.312
MIN CHAMFER C in	0.093	0.093	0.125	0.156
MAX FILLET RAD r_1 in	0.008	0.008	0.016	0.032
MAX FILLET RAD r_2 in	0.016	0.016	0.032	0.047
TOLERANCES				

Figures show the maximum permissible gap all on one side using minimum rod ϕ and maximum clearance ϕ .

Please refer to specified tolerances in the introduction - Housing & installation data - Hallite 500 Series

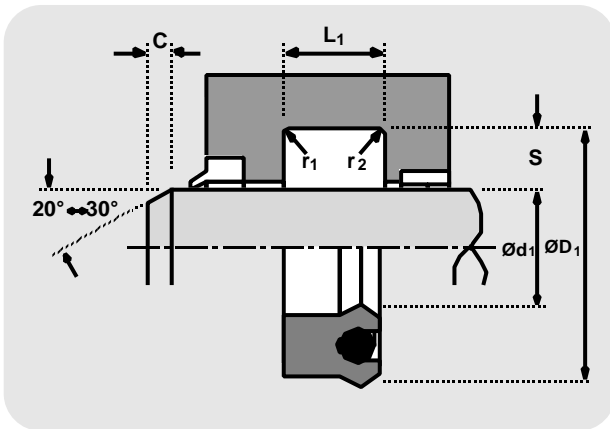

DESIGN

The Hallite 513 is a standard profile loaded U cup utilising a polyurethane or polyester shell energised by a high specification resilient O ring.

At zero or low pressure, the O ring helps to increase the sealing force preventing any bypass. As pressure rises the sealing force increases and the O ring provides complete lip actuation under most conditions. The precision trimmed sealing lips ensure optimum sealing action.

FEATURES

- FLEXIBLE FOR EASY INSTALLATION
- EXCELLENT RESISTANCE TO ABRASION
- POSITIVE LIP ACTUATION
- KNIFE TRIMMED PRECISION SEALING LIPS
- COMPACT HOUSING
- WIDE RANGE OF SIZES
- MATERIAL OPTIONS

MATERIALS

Seal material - O-Ring	last digit of part number
Standard material:	
Polyurethane - NBR	----- 10
Material options:	
Polyester - NBR	----- 11
Polyester - FKM	----- 12

Rod seals

Hallite 513

inch

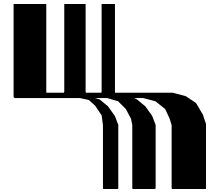
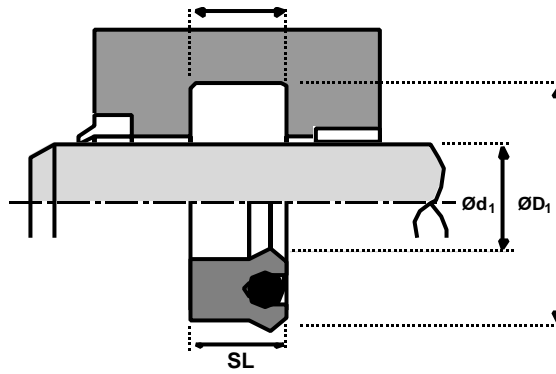

Ød ₁	ØD ₁	SL	L ₁	STD. REF.	PART No.
-----------------	-----------------	----	----------------	-----------	----------

1/8 CROSS SECTION

.250	.500	.187	.207	12500250-187B	8845910
.250	.500	.250	.275	12500250-250B	8878510
.375	.625	.250	.275	12500375-250B	8823810
.437	.687	.250	.275	12500437-250B	8846910
.500	.750	.250	.275	12500500-250B	8834010
.625	.875	.187	.207	12500625-187B	8848710
.625	.875	.250	.275	12500625-250B	8834110
.750	1.000	.250	.275	12500750-250B	8834210
.875	.125	.250	.275	12500875-250B	8845310
.875	1.125	.250	.275	12500937-250B	8845310
1.000	1.250	.187	.207	12501000-187B	8860110
1.000	1.250	.250	.275	12501000-250B	8834410
1.062	1.312	.250	.275	12501062-250B	8847510
1.125	1.375	.125	.275	12501125-125B	8899910
1.125	1.375	.250	.275	12501125-250B	8855610
1.125	1.375	.312	.344	12501125-312B	8848810
1.187	1.437	.250	.275	12501187-250B	8848910
1.250	1.500	.187	.207	12501250-187B	8860210
1.250	1.500	.250	.275	12501250-250B	8834710
1.375	1.625	.187	.207	12501375-187B	8860310
1.375	1.625	.250	.275	12501375-250B	8834910
1.437	1.687	.250	.275	12501437-250B	8849010
1.500	1.750	.250	.275	12501500-250B	8835210
1.625	1.875	.187	.207	12501625-187B	8849110
1.625	1.875	.250	.275	12501625-250B	8873110
1.750	2.000	.250	.275	12501750-250B	8835610
1.875	2.125	.187	.207	12501875-187B	8845810
1.875	2.125	.250	.275	12501875-250B	8845410
2.000	2.250	.187	.207	12502000-187B	8860410
2.000	2.250	.250	.275	12502000-250B	8873210
2.500	2.750	.250	.275	12502500-250B	8902210
2.875	3.125	.250	.275	12502875-250B	8844710
3.875	4.125	.250	.275	12503875-250B	8845510
4.875	5.125	.250	.275	12504875-250B	8845610

3/16 CROSS SECTIONB

.500	.875	.250	.275	18700500-250B	8848010
.500	.875	.312	.344	18700500-312B	8852910
.750	1.125	.187	.207	18700750-187B	8849810
.750	1.125	.250	.275	18700750-250B	8846010
.750	1.125	.312	.344	18700750-312B	8834310

Ød ₁	ØD ₁	SL	L ₁	STD. REF.	PART No.
-----------------	-----------------	----	----------------	-----------	----------

.750	1.125	.375	.413	18700750-375B	8855810
.875	1.250	.312	.344	18700875-312B	8900210
1.000	1.375	.187	.207	18701000-187B	8806110
1.000	1.375	.250	.275	18701000-250B	8860510
1.000	1.375	.312	.344	18701000-312B	8834510
1.062	1.437	.312	.344	18701062-312B	8850010
1.125	1.500	.250	.275	18701125-250B	8844910
1.125	1.500	.312	.344	18701125-312B	8834610
1.187	1.600	.312	.344	18701187-312B	8902310
1.250	1.625	.250	.275	18701250-250B	8860610
1.250	1.625	.312	.344	18701250-312B	8834810
1.250	1.625	.375	.413	18701250-375B	8860710
1.375	1.750	.250	.275	18701375-250B	8844710
1.375	1.750	.312	.344	18701375-312B	8835010
1.375	1.750	.375	.413	18701375-375B	8835110
1.500	1.875	.187	.275	18701500-187B	8851510
1.500	1.875	.250	.275	18701500-250B	8835310
1.500	1.875	.312	.344	18701500-312B	8849710
1.500	1.875	.375	.413	18701500-375B	8835410
1.500	1.875	.406	.447	18701500-406B	8848110
1.625	2.000	.250	.275	18701625-250B	8868410
1.625	2.000	.312	.344	18701625-312B	8864210
1.625	2.000	.375	.413	18701625-375B	8835510
1.750	2.125	.230	.250	18701750-230B	8852010
1.750	2.125	.312	.344	18701750-312B	8865410
1.750	2.125	.375	.413	18701750-375B	8835710
1.875	2.250	.375	.413	18701875-375B	8835810
2.000	2.375	.230	.250	18702000-230B	8806210
2.000	2.375	.250	.275	18702000-250B	8868110
2.000	2.375	.312	.344	18702000-312B	8860810
2.000	2.375	.375	.413	18702000-375B	8835910
2.125	2.500	.250	.275	18702125-250B	8845010
2.125	2.500	.375	.413	18702125-375B	8836010
2.250	2.625	.312	.344	18702250-312B	8860910
2.250	2.625	.375	.413	18702250-375B	8873310
2.375	2.750	.375	.413	18702375-375B	8861010
2.500	2.875	.375	.413	18702500-375B	8836210
2.625	3.000	.250	.275	18702625-250B	8868510
2.625	3.000	.312	.344	18702625-312B	8864310
2.625	3.000	.375	.413	18702625-375B	8836310
2.750	3.125	.187	.207	18702750-187B	8849910
2.750	3.125	.312	.344	18702750-312B	8846110

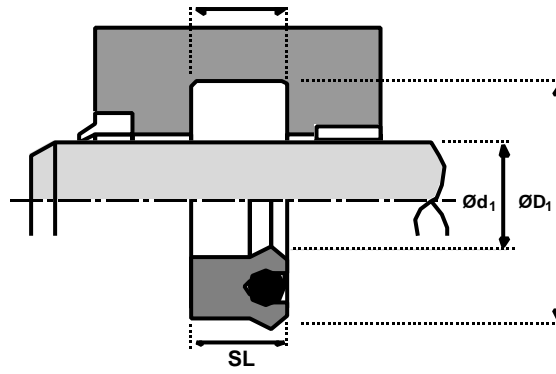
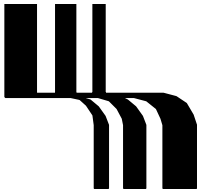

Rod seals

Hallite 513

inch

$\varnothing d_1$	$\varnothing D_1$	SL	L_1	STD. REF.	PART No.
2.750	3.125	.375	.413	18702750-375B	8836410
2.875	3.250	.375	.413	18702875-375B	8861110
3.000	3.375	.187	.207	18703000-187B	8806710
3.000	3.375	.250	.275	18703000-250B	8868210
3.000	3.375	.312	.344	18703000-312B	8861210
3.000	3.375	.375	.413	18703000-375B	8836510
3.125	3.500	.250	.275	18703125-250B	8845110
3.125	3.500	.375	.413	18703125-375B	8836610
3.250	3.625	.312	.344	18703250-312B	8861310
3.250	3.625	.375	.413	18703250-375B	8873410
3.375	3.750	.375	.413	18703375-375B	8836710
3.500	3.875	.375	.413	18703500-375B	8836810
3.625	4.000	.250	.275	18703625-250B	8868610
3.625	4.000	.312	.344	18703625-312B	8864410
3.625	4.000	.375	.413	18703625-375B	8836910
3.750	4.125	.187	.207	18703750-187B	8850210
3.750	4.125	.312	.344	18703750-312B	8846210
3.750	4.125	.375	.413	18703750-375B	8837010
3.875	4.250	.375	.413	18703875-375B	8861410
4.000	4.375	.187	.207	18704000-187B	8820010
4.000	4.375	.250	.275	18704000-250B	8868310
4.000	4.375	.312	.344	18704000-312B	8861510
4.000	4.375	.375	.413	18704000-375B	8837110
4.125	4.500	.250	.275	18704125-250B	8845210
4.125	4.500	.375	.413	18704125-375B	8837210
4.250	4.625	.312	.344	18704250-312B	8861610
4.250	4.625	.375	.413	18704250-375B	8837310
4.375	4.750	.375	.413	18704375-375B	8861710
4.500	4.875	.375	.413	18704500-375B	8837510
4.625	5.000	.250	.275	18704625-250B	8868710
4.625	5.000	.312	.344	18704625-312B	8864510
4.625	5.000	.375	.413	18704625-375B	8837610
4.750	5.125	.375	.413	18704750-375B	8846610
4.875	5.250	.375	.413	18704875-375B	8861810
5.000	5.375	.375	.413	18705000-375B	8842510

1/4 CROSS SECTION

.500	1.000	.375	.413	25000500-375B	8837710
.625	1.125	.312	.344	25000625-312B	8849210
.750	1.250	.375	.413	25000750-375B	8837810
.875	1.375	.312	.344	25000875-312B	8830210
.875	1.375	.375	.413	25000875-375B	8864610

$\varnothing d_1$	$\varnothing D_1$	SL	L_1	STD. REF.	PART No.
1.000	1.500	.375	.413	25001000-375B	8837910
1.125	1.625	.250	.413	25001125-250B	8804910
1.125	1.625	.375	.413	25001125-375B	8856110
1.250	1.750	.375	.413	25001250-375B	8838110
1.375	1.875	.375	.413	25001375-375B	8878610
1.375	2.250	.250	.413	25001500-312B	8805610
1.500	2.000	.312	.344	25001500-375B	8867710
1.500	2.000	.375	.413	25001625-375B	8838310
1.625	2.125	.375	.413	25001750-250B	8849610
1.750	2.250	.375	.413	25001750-375B	8838510
1.875	2.375	.375	.413	25001875-375B	8859410
2.000	2.500	.250	.413	25002000-250B	8856010
2.000	2.500	.375	.413	25002000-375B	8838610
2.125	2.625	.375	.413	25002125-250B	8856310
2.175	2.625	.250	.413	25002125-375B	8805810
2.250	2.750	.375	.413	25002250-375B	8838710
2.375	2.875	.375	.413	25002375-375B	8850110
2.375	2.875	.562	.413	25002375-562B	8900610
2.500	3.000	.312	.344	25002500-312B	8867810
2.500	3.000	.375	.413	25002500-375B	8839010
2.625	3.125	.375	.413	25002625-375B	8849310
2.750	3.250	.250	.413	25002750-250B	8805910
2.750	3.250	.375	.413	25002750-375B	8839110
2.875	3.375	.562	.619	25002875-375B	8900610
3.000	3.500	.375	.413	25003000-375B	8839310
3.000	3.500	.500	.550	25003000-500B	8842110
3.000	3.500	.562	.619	25003000-562B	8852210
3.125	3.625	.250	.413	25003125-250B	8848510
3.125	3.625	.375	.413	25003125-375B	8856210
3.250	3.750	.375	.413	25003250-375B	8839410
3.375	3.875	.375	.413	25003375-375B	8849410
3.375	3.875	.562	.619	25003375-562B	8900710
3.500	4.000	.312	.344	25003500-312B	8867910
3.500	4.000	.375	.413	25003500-375B	8839510
3.625	4.125	.375	.413	25003625-375B	8849510
3.750	4.250	.250	.413	25003750-250B	8846110
3.750	4.250	.375	.413	25003750-375B	8839710
3.750	4.250	.562	.619	25003750-562B	8839810
3.875	4.375	.375	.413	25003875-375B	8832510
4.000	4.500	.375	.413	25004000-375B	8840010
4.000	4.500	.500	.550	25004000-500B	8867510
4.000	4.500	.562	.619	25004000-562B	8840110

Rod seals

Hallite 513

inch

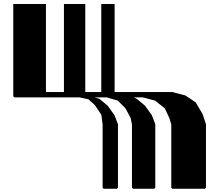
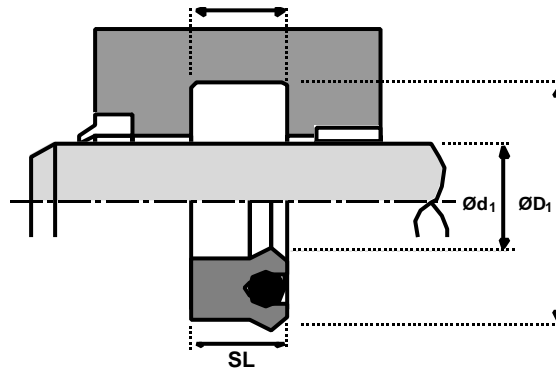

Ød ₁	ØD ₁	SL	L ₁	STD. REF.	PART No.
4.125	4.625	.250	.413	25004125-250B	8806010
4.125	4.625	.375	.413	25004125-375B	8856410
4.250	4.750	.375	.413	25004250-375B	8840210
4.375	4.875	.250	.413	25004375-250B	8848310
4.375	4.875	.562	.616	25004375-562B	8900510
4.500	5.000	.250	.344	25004500-250B	8817110
4.500	5.000	.312	.344	25004500-312B	8868010
4.500	5.000	.375	.413	25004500-375B	8840510
4.500	5.000	.500	.550	25004500-500B	8864710
4.500	5.000	.562	.619	25004500-562B	8840610
4.625	5.125	.250	.413	25004500-250B	8848410
4.750	5.250	.375	.413	25004750-375B	8861910
4.750	5.250	.500	.550	25004750-500B	8846310
4.750	5.250	.562	.619	25004750-562B	8840910
4.875	5.375	.375	.413	25004875-375B	8832910
5.000	5.500	.375	.413	25005000-375B	8841010
5.000	5.500	.500	.550	25005000-500B	8866810
5.000	5.500	.562	.619	25005000-562B	8841110
5.250	5.750	.562	.619	25005250-562B	8862010
5.500	6.000	.375	.413	25005500-375B	8841310
5.500	6.000	.500	.413	25005500-500B	8833610
5.500	6.000	.562	.619	25005500-562B	8841410
5.750	6.250	.375	.413	25005750-375B	8866410
5.750	6.250	.562	.619	25005750-562B	8841610
6.000	6.500	.375	.413	25006000-375B	8852310
6.000	6.500	.500	.550	25006000-500B	8867610
6.000	6.500	.562	.619	25006000-562B	8841710
6.500	7.000	.250	.275	25006500-250B	8899410
6.500	7.000	.375	.413	25006500-375B	8852610
6.500	7.000	.500	.550	25006500-500B	8846410
6.500	7.000	.562	.619	25006500-562B	8841910
6.750	7.250	.375	.413	25006750-375B	8865910
6.750	7.250	.500	.550	25006750-500B	8866010
6.750	7.250	.562	.619	25006750-562B	8866310
7.000	7.500	.375	.413	25007000-375B	8852410
7.000	7.500	.500	.550	25007000-500B	8842410
7.000	7.500	.562	.619	25007000-562B	8877910
7.250	7.750	.562	.619	25007250-562B	8862110
7.500	8.000	.375	.413	25007500-375B	8852510
7.500	8.000	.500	.550	25007500-500B	8833810
7.500	8.000	.562	.619	25007500-562B	8852810
8.000	8.500	.250	.275	25008000-250B	8899710

Ød ₁	ØD ₁	SL	L ₁	STD. REF.	PART No.
8.000	8.500	.562	.619	25008000-562B	8842310
8.500	9.000	.375	.413	25008500-375B	8852710
8.500	9.000	.500	.550	25008500-500B	8833910
8.500	9.000	.562	.619	25008500-562B	8853010

5/16 CROSS SECTION

Ød ₁	ØD ₁	SL	L ₁	STD. REF.	PART No.
1.000	1.625	.375	.413	31201000-375B	8828310
1.000	1.625	.500	.550	31201000-500B	8838010
1.125	1.750	.500	.550	31201125-500B	8879810
1.250	1.875	.312	.550	31201250-312B	8809810
1.250	1.875	.500	.550	31201250-500B	8838210
1.375	2.000	.312	.550	31201375-312B	8825110
1.375	2.000	.500	.550	31201375-500B	8873510
1.500	2.125	.375	.413	31201500-375B	8846510
1.500	2.125	.500	.550	31201500-500B	8838410
1.750	2.375	.375	.413	31201750-375B	8868810
1.750	2.375	.500	.550	31201750-500B	8873610
1.875	2.500	.500	.550	31201875-500B	8873710
2.000	2.625	.500	.550	31202000-500B	8873810
2.000	2.625	.562	.619	31202000-562B	8862210
2.125	2.750	.500	.550	31202125-500B	8879910
2.125	2.750	.625	.688	31202125-625B	8864810
2.250	2.875	.312	.550	31202250-312B	8816310
2.250	2.875	.500	.550	31202250-500B	8838810
2.375	3.000	.031	.550	31202375-312B	8827210
2.375	3.000	.500	.550	31202375-500B	8838910
2.500	3.125	.375	.413	31202500-375B	8836110
2.500	3.125	.500	.550	31202500-500B	8873910
2.750	3.375	.375	.413	31202750-375B	8868910
2.750	3.375	.500	.550	31202750-500B	8839210
2.875	3.500	.500	.550	31202875-500B	8874010
3.000	3.625	.375	.413	31203000-375B	8828510
3.000	3.625	.500	.550	31203000-500B	8874110
3.125	3.750	.500	.550	31203125-500B	8869810
3.250	3.875	.425	.550	31203250-312B	8820110
3.250	3.875	.500	.550	31203250-500B	8869710
3.375	4.000	.312	.550	31203375-312B	8827410
3.375	4.000	.500	.550	31203375-500B	8874210
3.500	4.125	.375	.413	31203500-375B	8837410
3.500	4.125	.500	.550	31203500-500B	8874310
3.750	4.375	.375	.413	31203750-375B	8869010
3.750	4.375	.500	.550	31203750-500B	8874410

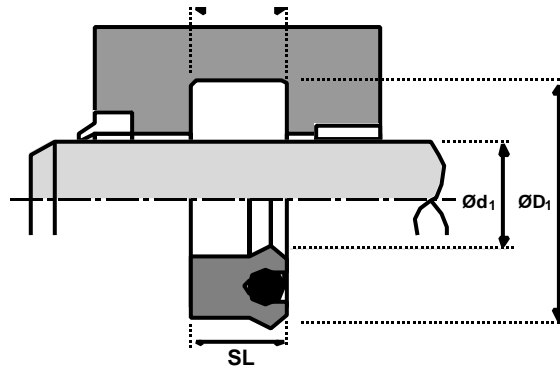
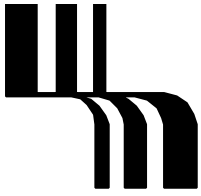

Rod seals

Hallite 513

inch

$\varnothing d_1$	$\varnothing D_1$	SL	L_1	STD. REF.	PART No.
3.875	4.500	.500	.550	31203875-500B	8839910
4.000	4.625	.500	.550	31204000-500B	8874510
4.000	4.625	.562	.619	31204000-562B	8862310
4.125	4.750	.500	.550	31204125-500B	8869610
4.125	4.750	.625	.688	31204125-625B	8869510
4.250	4.875	.312	.550	31204250-312B	8821610
4.250	4.875	.500	.550	31204250-500B	8869410
4.375	5.000	.312	.550	31204375-312B	8827610
4.375	5.000	.500	.550	31204375-500B	8874610
4.375	5.000	.625	.688	31204375-625B	8840410
4.500	5.125	.375	.413	31204500-375B	8840710
4.500	5.125	.625	.688	31204500-625B	8840810
4.750	5.375	.500	.550	31204750-500B	8869310
4.750	5.375	.625	.688	31204750-625B	8862410
5.000	5.625	.625	.688	31205000-625B	8874710
5.250	5.875	.625	.688	31205250-625B	8862510
5.375	6.000	.625	.688	31205375-625B	8841210
6.000	6.625	.625	.688	31206000-625B	8862610
6.375	7.000	.625	.688	31206375-625B	8841810
6.500	7.125	.625	.688	31206500-625B	8869110
6.750	7.375	.625	.688	31206750-625B	8862710
7.000	7.625	.625	.688	31207000-625B	8854810
7.250	7.875	.625	.688	31207250-625B	8862810
7.375	8.000	.500	.550	31207375-500B	8842610
7.375	8.000	.625	.688	31207375-625B	8864910
8.000	8.625	.500	.550	31208000-500B	8866610
8.500	9.125	.625	.688	31208500-625B	8862910

3/8 CROSS SECTION

1.250	2.000	.500	.550	37501250-500B	8842010
1.500	2.250	.500	.550	37501500-500B	8874810
1.500	2.250	.625	.688	37501625-375B	8842710
1.625	2.375	.375	.550	37501500-625B	8901010
1.750	2.500	.500	.550	37501750-500B	8874910
1.750	2.500	.625	.688	37501750-625B	8875010
2.000	2.750	.500	.550	37502000-500B	8875110
2.000	2.750	.625	.688	37502000-625B	8842810
2.250	3.000	.500	.550	37502250-500B	8875210
2.250	3.000	.625	.688	37502250-625B	8842910
2.375	3.125	.625	.688	37502375-625B	8846810
2.500	3.250	.500	.550	37502500-500B	8875310
2.500	3.250	.625	.688	37502500-625B	8843010

$\varnothing d_1$	$\varnothing D_1$	SL	L_1	STD. REF.	PART No.
2.625	3.375	.625	.688	37502625-625B	8863710
2.750	3.500	.500	.550	37502750-500B	8875410
2.750	3.500	.625	.688	37502750-625B	8843110
3.000	3.750	.500	.550	37503000-500B	8875510
3.000	3.750	.625	.688	37503000-625B	8843210
3.125	3.875	.625	.688	37503125-625B	8900310
3.250	4.000	.500	.550	37503250-500B	8875610
3.250	4.000	.625	.688	37503250-625B	8843310
3.375	4.125	.625	.688	37503375-625B	8852110
3.500	4.250	.500	.550	37503500-500B	8875710
3.500	4.250	.625	.688	37503500-625B	8843410
3.625	4.375	.625	.688	37503625-625B	8865310
3.750	4.500	.500	.550	37503750-500B	8875810
3.750	4.500	.625	.688	37503750-625B	8875910
4.000	4.750	.500	.550	37504000-500B	8876010
4.000	4.750	.625	.688	37504000-625B	8843510
4.250	5.000	.038	.550	37504250-375B	8867410
4.250	5.000	.500	.550	37504250-500B	8876110
4.250	5.000	.625	.688	37504250-625B	8843610
4.500	5.250	.500	.550	37504500-500B	8876210
4.500	5.250	.625	.688	37504500-625B	8843710
4.750	5.500	.500	.550	37504750-500B	8876310
4.750	5.500	.625	.688	37504750-625B	8876410
5.000	5.750	.500	.550	37505000-500B	8876510
5.000	5.750	.625	.688	37505000-625B	8843810
5.250	6.000	.500	.550	37505250-500B	8865010
5.250	6.000	.625	.688	37505250-625B	8843910
5.250	6.000	.750	.825	37505250-750B	8854410
5.500	6.250	.500	.550	37505500-500B	8863010
5.500	6.250	.625	.688	37505500-625B	8844010
5.750	6.500	.500	.550	37505750-500B	8866110
5.750	6.500	.625	.688	37505750-625B	8878010
5.875	6.500	.625	.688	37505875-625B	8900410
6.000	6.750	.500	.550	37506000-500B	8866210
6.000	6.750	.625	.688	37506000-625B	8844110
6.250	7.000	.500	.688	37506250-500B	8902410
6.250	7.000	.625	.688	37506250-625B	8844210
6.500	7.250	.500	.550	37506500-500B	8853310
6.500	7.250	.625	.688	37506500-625B	8844310
6.750	7.500	.500	.550	37506750-500B	8854610
6.750	7.500	.625	.688	37506750-625B	8854710
7.000	7.750	.500	.550	37507000-500B	8854010

Rod seals

Hallite 513

inch

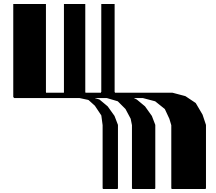
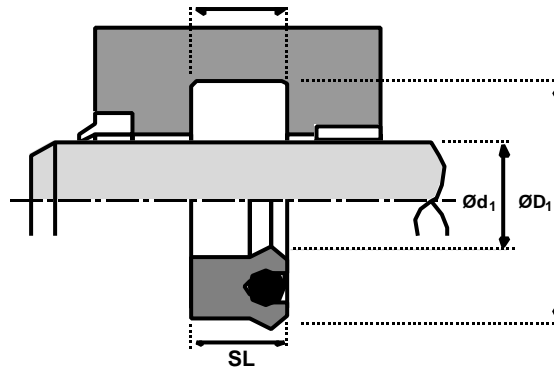

$\text{Ø}d_1$	$\text{Ø}D_1$	SL	L_1	STD. REF.	PART No.
7.000	7.750	.625	.688	37507000-625B	8844410
7.250	8.000	.500	.550	37507250-500B	8865110
7.250	8.000	.625	.688	37507250-625B	8844510
7.250	8.000	.750	.825	37507250-750B	8854510
7.500	8.250	.500	.550	37507500-500B	8863210
7.500	8.250	.625	.688	37507500-625B	8878110
7.750	8.500	.500	.550	37507750-500B	8865210
7.750	8.500	.625	.688	37507750-625B	8853610
8.000	8.750	.625	.688	37508000-625B	8878210
8.250	9.000	.625	.688	37508250-625B	8854110

1/2 CROSS SECTION

1.750	2.750	.750	.825	50001750-750B	8847010
-------	-------	------	------	---------------	---------

$\text{Ø}d_1$	$\text{Ø}D_1$	SL	L_1	STD. REF.	PART No.
2.000	3.000	.750	.825	50002000-750B	8876810
2.500	3.500	.750	.825	50002500-750B	8847110
3.000	4.000	.750	.825	50003000-750B	8863310
4.000	5.000	.750	.825	50004000-750B	8877410
4.250	5.250	.750	.825	50004250-750B	8847210
4.500	5.500	.750	.825	50004500-750B	8847310
5.250	6.250	.750	.825	50005250-750B	8847510
6.000	7.000	.750	.825	50006000-750B	8863410
6.250	7.250	.750	.825	50006250-750B	8847710
7.000	8.000	.750	.825	50007000-750B	8870410
7.250	8.250	.750	.825	50007250-750B	8847810
7.750	8.750	.750	.825	50007750-750B	8847910
8.000	9.000	.750	.825	50008000-750B	8863510